



VIRGINIA GUN COLLECTORS ASSOC., INC.

WWW.VGCA.NET

Est. 1983 (A Not-for-Profit Organization)

NRA Affiliate Number G8162

CMP Affiliate Number 026160



President
Show/Reservations Manager
Membership

Rob Becker
Andrew Woodard
George Dungan

Phone: 703-441-1211
Cell: 301-613-5718
Phone: 571-243-6387

rpebecker@verizon.net
ajw055570@aol.com
george@eccominv.com

Website: www.vgca.net
Facebook: @VirginiaGunCollectorsAssoc

Twitter: @VAGunCollectrs
Instagram: @vaguncollectors

September 2024 VGCA Newsletter

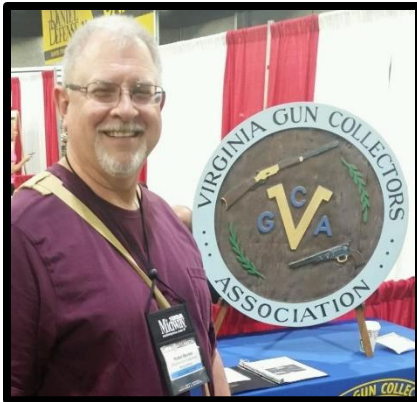

PRESIDENT'S NOTES

Greetings fellow members—

I am very much looking forward to our September Membership Meeting with Matt DiRisio talking to us about the Finnish Mosin-Nagant rifle. Matt is a VGCA member and the author of a superb book that is the definitive work on this subject. It should be an interesting and educational evening!

If you can't make it to the meeting in person, remember, you

can sign up via Webinar and watch the presentation from your computer either in real time that night or later at your leisure.

As the weather cools off and summer yields to autumn, we are reminded that the time is quickly approaching for our fall show - next month, to be exact! We will have our fall gun show at the Dale City Veterans of Foreign Wars Post #1503 on 19-20 October. I just found out that we have sold every table so it should be a good show. I ask that everyone planning to attend bring a friend or neighbor! And if you would like to volunteer for either show security or to man our membership table, please contact Al Reid or Bruce Buchner.

Finally, I want to remind you of our two VGCA-sponsored tours this year - the first will be to Knight's Armament and the Institute of Military Technology (Titusville, FL) on Friday, November 1st, and the other tour is of the National Museum of the Marine Corps (Triangle, VA) on Saturday, November 16th. Be sure to sign up if interested in attending.

Cheers!

Rob Becker, VGCA President

★ August Presentation – The FAL RIFLE

VGCA member and long-time Fabrique Nationale (FN) employee Carlos Davila continued his series of presentations on their products – this one on the FAL (*right*). The Fusil Automatique Léger (which is French for Light Automatic Rifle) aka FAL, was designed by Dieudonné Saive, a Belgian small arms designer who worked for FN for many years. Saive completed John Browning's work on the High Power pistol and had worked on the FN-49 semi-automatic rifle before taking on the select fire FAL. Originally designed for the intermediate caliber .280 British, it was re-designed to handle the newly adopted NATO 7.62x51 caliber.

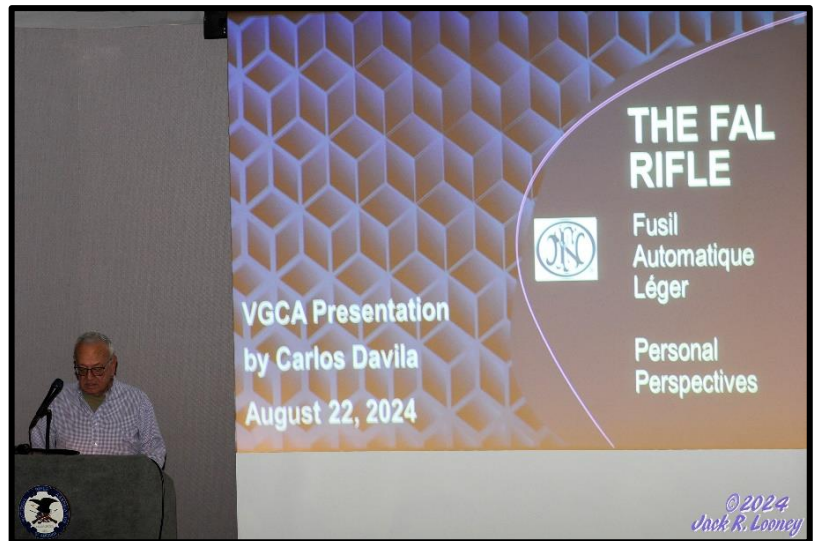

The FAL (test samples were designated the T48) competed against the T44 in U.S. trials in the 1950s to replace the M1 rifle and the M1918 Browning Automatic Rifle. In a controversial decision, the T44 design was approved as the next rifle for the U.S. Army and designated the M14. It is fairly safe to say that the FAL was a victim of the “not invented here” syndrome.



Undeterred, FN continued to market the FAL around the world, where it would eventually serve as the main battle rifle in over 90 countries. An “inch pattern” semi-automatic only variant (called the Self Loading Rifle or SLR) would be produced in the United Kingdom, Australia, and Canada. A standard metric-dimensioned FAL was manufactured in South Africa, Brazil, Israel, Austria and Argentina. Both the SLR and FAL were also produced without license by India. Carlos shared a table with FN FAL production numbers.

A great many variants of the FAL and SLR would be made, including a heavy barrel version (for more sustained fire), a carbine version (for paratroopers), and a sniper/designated marksman version. Many of these variants were brought in by Carlos (*above left – from top*), including a heavy barrel variant with scope, a Peruvian model, a paratrooper with scope marked “.308 Match”, an FN

made short-barreled paratrooper, an Australian L1A1, a rare D3NX with rotating sight, an Imbel, another FN, and G1 style (like those delivered to the German Border Patrol in the mid-1950s.



Carlos started in the firearms business by working for Sam Cummings and Interarms. His connection with the FAL began when he was allowed to borrow one to use in a rifle match in Peru, where he was impressed with its ability to be competitive with custom target guns. Later, Carlos would be hired by FN to be the FN sales representative for Latin America, Portugal, and Spain.

Carlos shared many fascinating memories of his work over the years (*at left*). He acknowledged that some FAL clones sold in the U.S. have reliability problems originating from the inconsistent quality of some parts kit builds. This was never an issue with original FN made rifles as those guns “were built to Spec” and quality control was strictly enforced. DSA currently manufactures FAL clones, and their quality is pretty good.

Carlos warned that the headspace should be checked on any newly purchased kit-built FAL/SLR. He cited the cautionary tale of one poorly made example (not from DSA) that “mushroomed” the piston after just two magazines and subsequently “swallowed a NO GO gauge”!

The FAL was the symbol of the West’s defiance of communism during the Cold War. It continues to soldier on around the

world almost seven decades after its initial introduction. The FN FAL is truly a classic!

The next time you see him, be sure to thank Carlos for his taking the time to share te story of the FAL with us!

POSTSCRIPT: At the end of Carlos’ presentation, someone came up to him and showed him pictures of a High Power pistol. Carlos did not know what it was, and he asked FN expert Anthony Vanderlinden, but he also didn't know. Carlos asked for the person to bring the pictures to the next meeting.





★ August Meeting Notes

VGCA President Rob Becker called the August membership meeting to order at 7:00 p.m. Jim Burgess led us through the Pledge of Allegiance and a moment of silence in honor of our fallen veterans. New members and guests were introduced. There were 53 members and guests in attendance and an additional 9 people participated via webinar.

Rob discussed plans for a field trip on November 1st to Knights Armament in Titusville, FL as well as a future trip to the National Museum of the Marine Corps in Quantico VA on November 16th. Signup sheets were passed around for those interested. More information will be forthcoming at the September meeting.

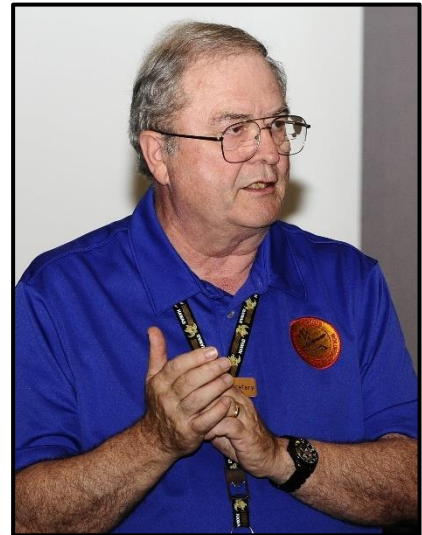

Bruce Buchner (*right*) displayed a T-shirt and polo shirt made by Land's End and embroidered with the VGCA logo. A program has been established that allows members to purchase clothing items of their choosing from the Land's End catalog and have the VGCA logo embroidered on them for an additional \$8.95 charge. Details on how to do it are in the newsletter (see page 13).

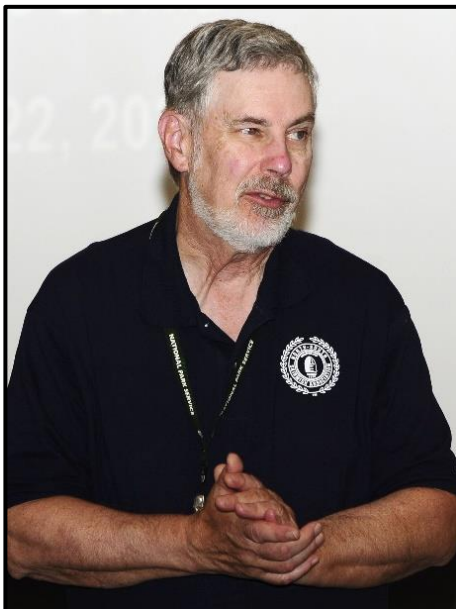

Jim Burgess (*left*) discussed the upcoming North-South Skirmish Association's 150th National Match being held October 2-6, 2024, at Fort Shenandoah, 480 Chalybeate Springs Rd., Winchester, Virginia. More details are available at: [North South Skirmish Association \(n-ssa.org\)](http://NorthSouthSkirmishAssociation(n-ssa.org)). Rob mentioned he was looking forward to the cannon match on Saturday, October 5th and reminded everyone that Taylor's and Company Firearms is located in Winchester.

George Dungan gave the membership report. We have 435 life members, 80 Annual and 7 applicants.

Shannon Ziegler made an abbreviated treasurer's report so he could give a PowerPoint presentation on a potential site in West Virginia for a club shoot and picnic. There just isn't sufficient time to have a picnic this year, but once the 2025 dates for our gun show are set, we can look at setting this up.

Andrew Woodard gave a short report on the October VGCA Gun Show. Only 14 tables remain so if you want to sell or display contact Andrew very soon. UPDATE: As of the writing of this newsletter, all tables are sold out and Andrew has established a waiting list.

Rob then introduced Carlos Davilla as the evening's speaker.



★ Next Membership Meeting: September 26th

Presentation: "The Finnish Mosin-Nagant" by Matt DiRisio (see the ad for his excellent book on this topic on page 30)



Location: NRA HQ Basement Auditorium

Our September VGCA Membership Meeting will be in the basement auditorium of the NRA Headquarters. The room will open at 6 p.m. with pizza (we are asking for a \$5 donation per person for the pizza) arriving shortly thereafter and the meeting starting at 7 p.m. Accompanying Matt will be noted firearms author Anthony Vanderlinden. We hope you can make it!

RUGER SR22 SAFETY BULLETIN



Ruger has updated a March safety bulletin (See VGCA Newsletter of March/April 2022) about faulty SR22 pistols and has expanded the range of potentially affected guns. According to Ruger, in rare instances, if the left and right frame inserts of Ruger SR22 pistols are not properly secured together, the firing pin blocker lifter and hammer block can move independently of each other, potentially rendering them ineffective. **If this situation occurs, the pistol will intermittently**

exhibit a "slack" single-action trigger and has the potential to discharge if decocked over a live round. *A "slack" single-action trigger occurs if, while operating the pistol in single-action mode with a magazine inserted, the slide forward, and the manual safety disengaged, a trigger pull does not encounter resistance and the hammer does not fall.*

According to Ruger, if you experience a slack single-action trigger while shooting, take the following steps immediately:

- 1) Keep the pistol pointed in a safe direction at all times.
- 2) **DO NOT engage the safety lever.**
- 3) Remove the magazine from the pistol.
- 4) Retract the slide and lock it back.
- 5) Visually and physically verify that the chamber of the pistol is empty.
- 6) With the pistol pointed in a safe direction, the chamber empty, and the magazine removed, carefully close the slide and engage the safety lever to decock the pistol.

If you experience either a slack trigger or a discharge upon decocking, please immediately stop using your SR22 and return it to Ruger for a Safety Retrofit. Any SR22 that has not previously been retrofitted with serial number **369-89043 or lower** (including those with a "SS" serial number prefix) is subject to this Safety Bulletin, if it has either: **(1)** exhibited (or exhibits in the future) a slack single-action trigger; or **(2)** discharged upon decocking. If you have ever experienced either of these conditions with your SR22 pistol, you should stop using your pistol and sign up for the Safety Retrofit. SR22 pistols with a serial number of **369-89044 and above are not affected by this Safety Bulletin.**

For additional information, including instructions about how to send your pistol back to Ruger, see the Ruger website at <https://www.ruger.com/dataProcess/sr22retrofit/?r=announcements>.

HORNADY AMMUNITION RECALL NOTICE

Hornady® is recalling sixteen (16) lots of item #81199, **350 Legend 150 gr. SP Hornady BLACK® ammunition**. These lots were shipped between the dates of November 2, 2023, and August 19, 2024.

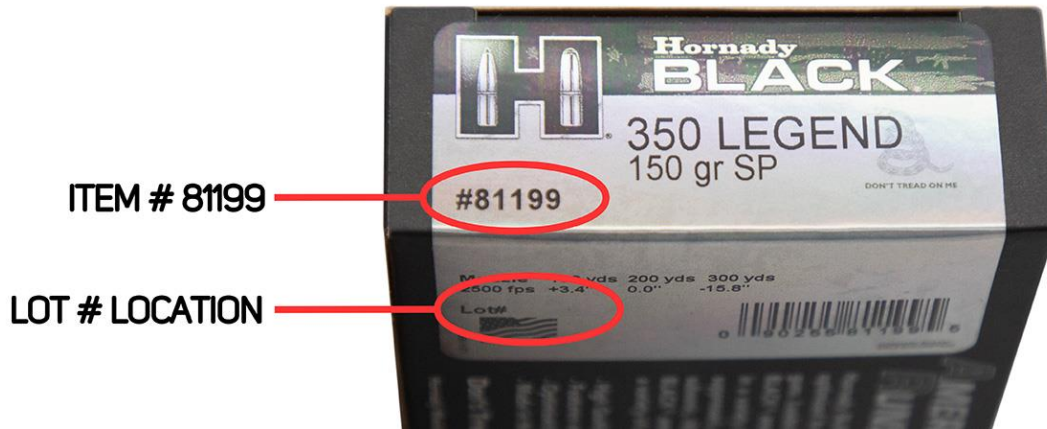

ITEM #81199

LOT #'s: 3234613, 3241530, 3241634, 3241678, 3241990, 3241991, 3242096, 3242414, 3242590, 3242597, 3242695, 3242868, 3242894, 3243421, 3243705, 3243974

Hornady ballisticians have determined that cartridges from lot #'s: 3234613, 3241530, 3241634, 3241678, 3241990, 3241991, 3242096, 3242414, 3242590, 3242597, 3242695, 3242868, 3242894, 3243421, 3243705, 3243974 may exhibit high pressure. Use of this product may result in firearm damage and/or personal injury.

This notice only applies to item: #81199 and the lots listed above, which are can be found printed on the box label (see photo).

If you own any of the lot numbers listed above or have any questions regarding this recall, please call 800-338-3220. Hornady Manufacturing Company will make all arrangements associated with this return and replacement of the product.

★ Upcoming Tours

The VGCA is pleased to announce that we have arranged a tour of Knight's Armament and the Institute of Military Technology Museum in Titusville, Florida, on Friday, 1 November 2024. Former VGCA President and current employee of Knight's Armament, Mr. Bernie Breighner, has promised us a full day of activity.



In addition, we will visit the National Museum of the Marine Corps, Triangle, Virginia, on Saturday, 16 November 2024. More details, including sign-up rosters, will be provided at our membership meetings between now and November.

IT'S A CHUCHU!

But not a choo choo train.

By Marc Gorelick



Right side of Chuchu pistol. Photo courtesy of Morphy Auctions, Denver, PA.

From the earliest days of firearms men have tried to make smaller handguns that were easy to conceal. It wasn't until the wheellock that small pistols (one handed short gun) could be concealed since it was hardly practical to carry a matchlock with burning cord beneath one's cloths. In fact, small wheellock pistols became so common among the wealthy upper classes in the early 1500's, and started to cause so many deaths, that several civil authorities in Europe passed edicts banning them. For instance, in 1523 a city ordinance in Ferrara, Italy outlawed wheellock weapons. It reads in part,

"An especially dangerous kind of firearms have come to be used, which are called wheellock, with which a homicide can easily be committed. His Excellency, knowing that these are devilish arms, prohibits their being carried without explicit authorization, under penalty of having a hand publicly cut off."

These edicts and laws, however, did not stop the development, manufacture or use of smaller and smaller handguns that could be easily carried. As firing mechanisms progressed from wheellock through the snaphaunce, flintlock and percussion to metallic cartridge, guns could be made smaller and more easily concealed.

Armand (or Athanasio/Athanase) Chuchu was an obscure Brazilian firearms designer from Salvador in Bahia state who designed a unique breech-loading, four barreled folding pistol in 1884. His idea was to make the pistol more compact for concealed carry. He accomplished this by putting a hinge on the front bottom of the frame to which the cluster of four barrels is attached. Although the pistol's design, with its four drop-down barrels and fixed breech superficially resembled the better known (and larger) British Lancaster and less well-known Martin-Marres-Braendlin Mitrailleuse 4-barrel pistol. Chuchu's design

permitted the barrels to be folded further than usual so that they could lie snug against the grip. This made the gun an extremely compact unit that could be carried in a pocket.



Left side of Chuchu pistol. Note A. CHUCHU /PATENT in a box over serial number 363. Note the knob in front of the muzzles for the manual extractor. Photo courtesy of Morphy Auctions, Denver, PA.

Chuchu received a Belgian patent for his design in February 1884 and British patent number 11201 in 1884. He then applied for and was awarded United States Patent 325,053 on August 25, 1885. His pistols were most probably manufactured by the Belgian firm of Lambin et Theate, located at Rue Trappe 5, in Liege.



Top and bottom views of the Chuchu pistol. Photo courtesy of Morphy Auctions, Denver, PA.



The pistol's firing mechanism design resembled that of the Sharps four-barreled pistols, with the rotating firing pin on the nose of the internal hammer rotating to the right to fire each succeeding cartridge in turn as the trigger is pulled. The pistol is double action with a folding trigger that unfolds when the gun is ready to be fired and folds out of the way when the barrel cluster is folded over against the grip.

The barrels, which are held against the action by a catch or latch, are folded down to expose the four chambers for loading. The latch is attached to a hinge on the top of the barrel cluster. It is securely attached to a stud on the top of the frame when the barrel cluster is in the firing position. The barrel cluster is released for loading by lifting the latch at the rear off the frame mounted stud. When the barrels are folded all the way down, the barrel catch can be folded down to completely cover the rear of the barrels, acting as a retaining plate that holds the cartridges in place and ensures that they will not fall out of the chambers when the pistol is carried in the folded position.

(No Model.)

A. CHUCHU.
REPEATING FIRE ARM.

No. 325,053.

Patented Aug. 25, 1885.

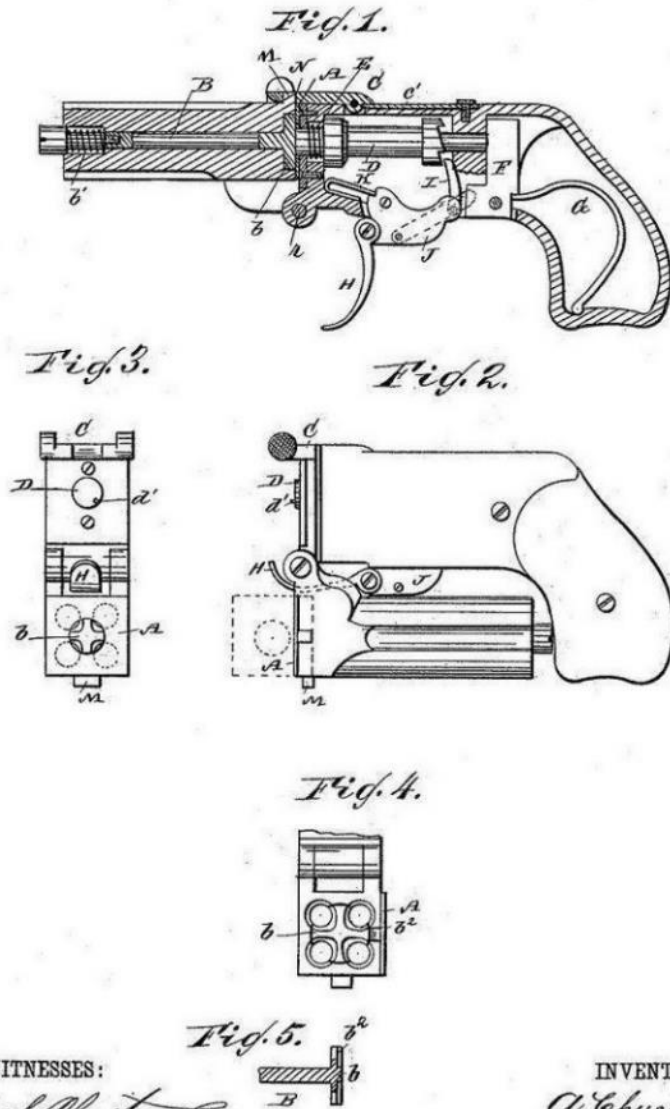

Left - Chuchu patent drawing for US Patent 325,053 dated August 25, 1885. Note the rotating firing pin mechanism (Fig.1) and the pistol folded for carrying (Fig. 2). The hinged catch or plate is shown in Fig. 3. Image – US Patent Office.

The guns are .22RF with four two-inch long barrels that are grouped around a manual spring-loaded extractor. The guns have a nickel finish. Some are plain without any engraving and others have the frame and barrels decorated with tasteful foliate scroll and border engraving. **A. CHUCHU / PATENT** in a rectangular box is stamped on the left side of the frame over the serial number. A crown over the initials **HF** is stamped on the top of the frame. Both the frame and the barrels have Belgian proof marks – **E / LG / Star** inside an oval. The pistols have two-piece checkered gutta percha grips. There is an **AC** monogram at the top of the grips.

The little Chuchu pistol is quite rare today and can bring high prices among collectors, depending on the condition. Morphy Auctions had one that was offered at a September 2024 auction that was estimated at \$1,500-\$2,500. Rock Island Auctions sold one at a September 2007 auction that was estimated as \$4,500 to \$7,500 and one with no engraved decoration at a December 2023 auction that was estimated at \$1,600-\$2,500. Cowan's offered one at a November 2015

WITNESSES:
Wm. J. ...
to Sedgwick

INVENTOR:
A. Chuchu
 BY *Munn & Co*
 ATTORNEYS.

H. PETERS, Photo-Lithographer, Washington, D.C.

auction that had an estimate of \$1,250-\$2,500. And Gregg Martin Auctions offered one at a November 2006 auction with an estimate of \$3,500-\$4,000. (Remember - condition is an important factor in estimates). It is not known exactly how many were made but there was one sold at a Christie's auction with a serial number of 976.



Chuchu pistol with no engraving and trigger folded forward. Photo – private collection.



Chuchu pistol with barrels folded down for loading. Note the face of the rotating firing pin on the front of the frame and the latch which can be folded to cover the chambers. Photo – private collection.



Chuchu pistol with barrels folded down. Note the rotating firing pin on the left and the extractor plate for the manual extractor by the chambers. Photo – private collection.

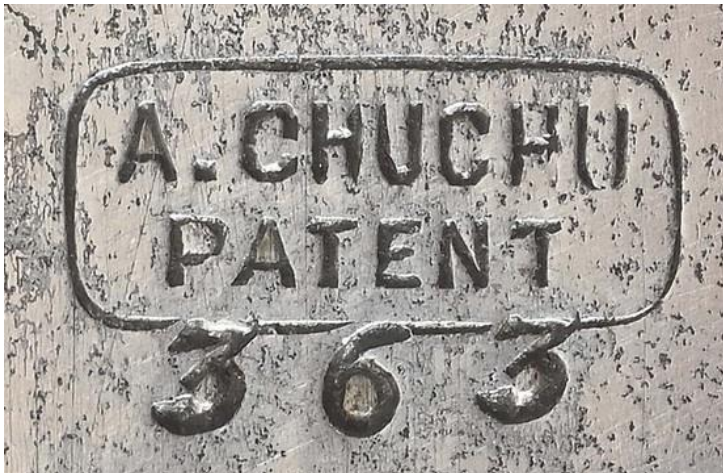

*Above left – Chuchu stamp on the left side of the frame above serial number.
Above right – Crown over HF stamp on the top of the frame. Note stud on right for the latch plate.
Both photos are courtesy of Morphy Auctions, Denver, PA.*



Belgian Liege proof stamp on Chuchu pistol. Photos courtesy of Morphy Auctions, Denver, PA.

Lambin & Théate
Fabricants d'Armes
 Rue Trappé - LIEGE
 — 16 Fevr. 84 —

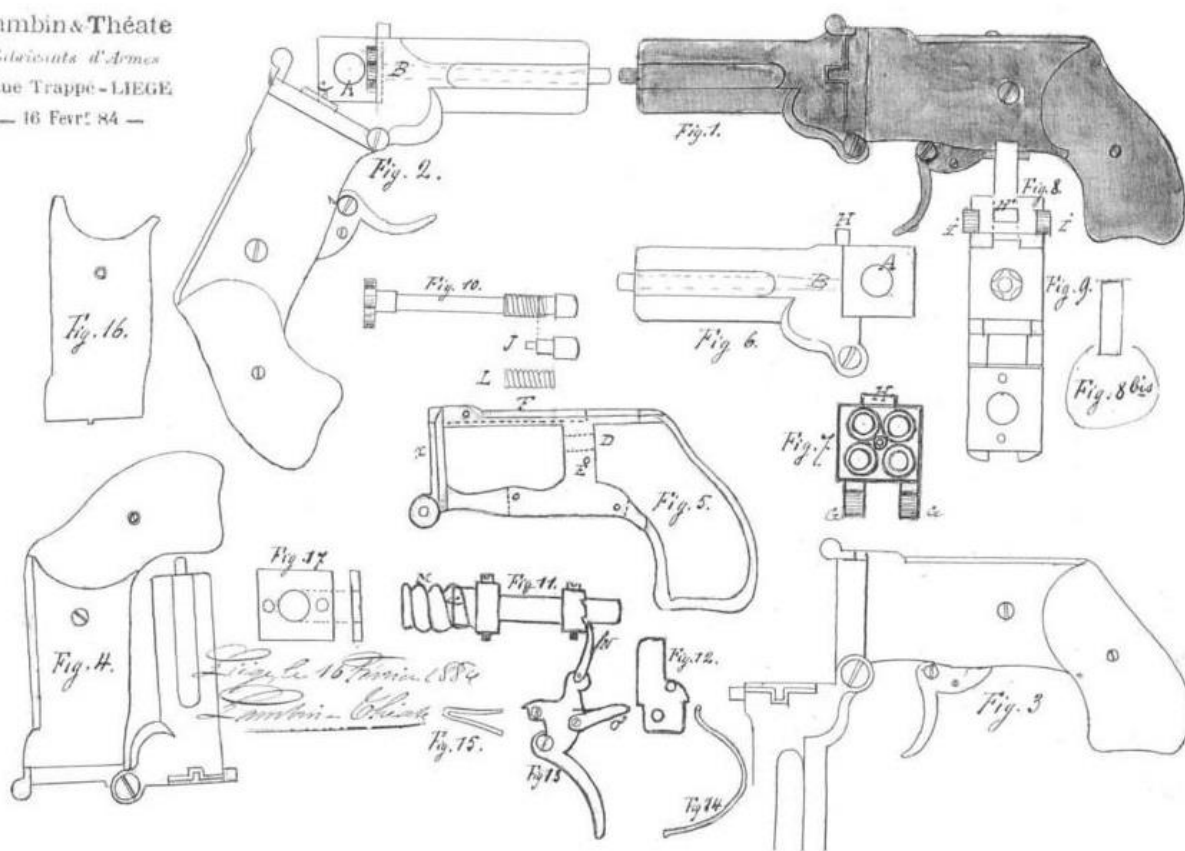

Lambin & Théate drawing of Chuchu pistol possibly from Belgian patent dated February 16, 1884. Public Domain.

Armand Chuchu also designed a breechloading rifle that is also extremely rare today. This is a little-known weapon that was used primarily in Brazil by the Bahia State Police. He patented it in England (Patent Number 3543, dated March 12, 1886), based on an interesting revolving block system that appears to be unique to Brazil. John Walter, in *Rifles of the World*, described the operation:

"An operating lever on the right side of the breech was pulled back to cock the hammer and then outward to swing the entire breech block laterally to the right. The spent case was extracted as the movement was completed."

The Brazilian army tested the Chuchu rifle in February 1886 and although it gave satisfactory results, (17 rounds per minute rapid fire and 12 rounds per minute aimed fire), decided not to adopt it. The Brazilian army was already armed with the Comblain rifle and the Chuchu did not provide any it advantages over the Comblain. And more advanced rifles were on the horizon.

Despite its rejection by the Brazilian Army, Chuchu's home state of Bahia purchased 900 Chuchu rifles in 1891 to equip the State Police. They were manufactured by the Belgian firm of Lambin et Théate, of Liège (just coincidentally Chuchu was the firm's representative in Bahia). Chambered for the short (11x42R) Comblain cartridge, the rifles were delivered in 1892 and issued in 1893. By that time, they were already obsolete and were soon replaced in Bahia State Police service by German Model 1888 Commission Rifles, Brazilian Comblains or Mauser Model 1894s. After that the Chuchu rifles effectively disappeared so completely that today it is almost impossible to find a decent photograph of one.



★ VGCA Logo Available at Lands' End

We have recently coordinated a custom service with the Lands' End apparel company. They have digitized our VGCA logo and loaded it into their computer guided embroidery machines. For an additional \$8.95 fee, you can have our logo embroidered on a huge selection of men's and women's clothing items. And it is actually embroidered on the item – not just a sewn-on patch. You get to pick the style, size and color (*example at right*).



Here's how to order your apparel:

1. Go to the VGCA store on Lands' End business:

<https://business.landsend.com/store/vgca>

It must be the URL shown above. **Do not** go to the regular Lands' End website. It will not show our logo options.

2. Above the photo on the home page click on “Men” or “Women”
3. On the drop-down menu select what you are interested in. For example, Men>Activewear >Tops gives you 19 different styles and fabrics of men's shirts. When you have selected an item click on it and select your color, size and quantity. Then on the lower right-hand corner of the screen click on the blue “Apply Logos” button.
4. On the next screen click on the VGCA logo to choose it and it will open the “select a Location” menu showing where you can have the VGCA logo embroidered. Choose a location and then scroll down to the “Apply Logo” button in the lower right corner and click it. It will return you to your garment page.
5. If you are satisfied with your garment, color, size and logo location click on the “Add to Bag” button in the lower right corner.
6. Then you can then go to checkout or continue shopping. When you checkout it will show an additional \$8.95 for the embroidery.

If you have any questions, you can reach Bruce Buchner at 703-339-8212 or Buchnerb@cox.net

★ More Merch - VGCA Tee Shirts



New VGCA Tee Shirts are now available for purchase. Tan colored and featuring the VGCA patch on the left breast, the VGCA logo on the right sleeve, and the Virginia state flag on the left, they are available in sizes from medium up to XL. The cost is \$20, and they can be purchased at our membership meetings – but don't wait – there are only about 20 left!

Member Bryan Pelton (on left) was selling VGCA Tee Shirts at our November Gun Show while Bruce Buchner (on right) proudly wore his new shirt while manning the membership table.

★ Do you love history and firearms...

like being organized, have a decent command of the English language, possess fair computer skills, and can dedicate a few hours each month to the VGCA? Then you may be just the person to take over as our newsletter editor! Rob Becker will continue as our editor through the end of this year but is looking for some relief. If you think this is something you would be willing to take on, please contact any officers or directors.

★ N-SSA 150th National Skirmish

By Rob Becker

The North-South Skirmish Association is about to reach a significant milestone and will host their 150th National Skirmish on the first weekend in October (2-6 Oct).



The event schedule for Saturday, October 5th is shown below. Former VGCA President Jim Burgess will be competing in the Carbine Company Match in the morning, and I am very much looking forward to seeing (and hearing – you may want to bring hearing protection) the artillery matches in the afternoon.

- 7:30-10:00 Tenderfoot Individual Matches – revolver range (targets, air rifles & safety glasses issued). These matches are for skirmish family members still too young to heft a musket
- 8:30-12:00 Carbine Company Match
- 1:00-5:00 Artillery Matches
- 7:30-9:00 Twilight Cannon Demonstration

Between the competitive shooting, the vendors on Sutler's Row, and proximity to Taylor's & Company Firearms in Winchester, there should be more than enough activity to keep me entertained!

For more details and a complete schedule, go to [North South Skirmish Association \(n-ssa.org\)](http://NorthSouthSkirmishAssociation(n-ssa.org)).

★ 2024-2025 Presentation List ★

| MEETING DATE | TOPIC | PRESENTER |
|--------------|---|---------------|
| 26 Sep 2024 | The History of the Finnish Mosin-Nagant | Matt DiRisio |
| 24 Oct 2024 | Assault Rifles 101: Birth of the Kalashnikov AK-47 | Bryan Pelton |
| | <i>No meeting in November due to our Fall Gun Show / Tours / Thanksgiving</i> | |
| TBD Dec 2024 | Annual Holiday Potluck & Swap Meet – no presentation | |
| 23 Jan 2025 | The Winchester Winder Musket | Rob Becker |
| 27 Feb 2025 | The Winchester Model 1894/Model 94 | George Dungan |

If you have any presentation suggestions – or would like to make a presentation yourself in 2025 – please contact Matthew G. at matthewofmclean@gmail.com or one of the VGCA officers or directors.

VGCA GUNS OF DISTINCTION: FLINTLOCK RIFLE WITH ADJUSTABLE STOCK

By Marc Gorelick

Photos courtesy of Joh. Springers Erben, Vienna, Austria

There is a saying, taken from Ecclesiastes 1:9, that there is nothing new under the sun. In the world of firearms there are arguments both ways. Although many believe that the telescoping stock first made its appearance with AR-type rifles, it appears that telescoping stocks were around 200 years earlier.



Illustrated here is a .63 caliber German flintlock rifle (or rifle-carbine) that was made around 1800 with a telescoping stock. It is a short gun, only 28.3 inches (72mm) long (72mm). It has a short 16 inch (41cm) long bright octagon barrel that is slightly swamped and has 7 deep rifling grooves. A rather plain yet sturdy gun, it has dovetailed sights, a flat, curved, unadorned lockplate, and a more ornate curved and pierced counter-plate. The full walnut stock has a very short butt. It has brass furniture, including a brass buttplate and ramrod pipes. The original ramrod has a bone tip.



What makes this gun remarkable is its telescoping adjustable buttstock. The buttplate is connected to a steel rod that slides into and out of the butt. Notches in the rod lock the plate at various lengths to accommodate the shooter. While the gun is in excellent condition, there are no maker's marks, so we don't know who made it.

This handsome gun was offered at auction by Joh. Springer's Erben, Vienna, Austria with a starting price of \$537 (450) euros.

MYSTERY SOLVED!

Several years ago, the VGCA secretary received an inquiry from a member of the Alaska Gun Collectors Association. This individual was trying to identify a disk mounted on a New Model Evans repeating rifle (*below*). We published the disk image (*below right*) in the newsletter for several issues, hoping someone could assist our collecting brother on the last frontier!



In December of 2022, one of our VGCA members, Mr. Jack Looney, posted the following on several collector forums:

“This was sent from a member of the Alaska Gun Collectors Association, hoping to identify a disk mounted on the foregrip of a New Model Evans repeating rifle, circa 1878.

The lower letters would appear to be either “MA” or “AM”.

If anyone has an idea, reference, or document, that will shed light on this, it will be most appreciated.”

On September 10th of this year, Jack received a reply to his post on the International Ammunition Association Forum. It came from Mr. Stephen J. Shephard, who goes by “OpenIrons” on the forum and is a member of the Alaska Gun Collectors Association. It reads:

“Years later, here I am showing up at this forum, and am very pleased to see that this question had made it here. I’m also delighted to be able to provide an answer on this one, as it’s quite fascinating. The inlayed disc was originally a lapel broach (*example at right*).

The letters should be properly read as, “S O MA”, standing for “Secrecy/Obedience/Mutual Assistance”. This was the motto of the Knights of Labor, which started out as a secret society, (an era from whence this pin dates), and then became one of the first national labor unions in America.”

It is good to get answers to our collecting questions – even two years later – and to know that our members’ efforts to research and identify details in the collector world are appreciated!



Imaged by Heritage Auctions, HA.com

VGCA MEMBER'S COLLECTION TO BE AUCTIONED



Long-time VGCA member John Vagnetti's superb collection of Harper's Ferry Rifles is scheduled to go on the auction block on October 23/24, 2024. These fine examples will be offered by Cowan's Auctions at: 5030 Oaklawn Drive Cincinnati, OH 45227

You can view the guns at the Cowan's website (<https://cowans.hindmanauctions.com/>) once the auction is posted.

The guns include specimens of 10 rifles manufactured at the US Armory at Harper's Ferry, Virginia. They are documented with their provenance and are listed below:

1. U.S. Model 1803 (Type II) dated 1816. Original Flint (VG-Fine) Ex. William Gerber & Robert Howard collections.
2. U.S. Model 1841 Dated 1850. (VF-Excellent) Ex. Ted Heske collection.
3. U.S. Model 1841 (Type 1-B) (VG+) Ex. George Moller.
4. U.S. Model 1841 (Type II-A) (VG+) Ex. George Moller.
5. U.S. Model 1841 (Type II-B) (VG+) Ex. Frederick Goldbecker.
6. U.S. Model 1841 (Type II-C) (Fine+)
7. U.S. Model 1841 (Type III) (VG+)
8. U.S Model 1855. (Fine) Cowan's Auction.
9. U.S. Model 1855 (Type-IV) (Fine) Ex. Everett "Birdie" Partridge collection.
10. Model 1855 (Confederate Assembled) Subject of an article in *North South Trader's Civil War* magazine, Vol. 34, No. 4 2009.

John is also auctioning a Lewis and Clark Rifle (reproduction), identical to the one in the National Firearms Museum at the NRA.

So, if you ever wanted a piece of American history in the form of one or more genuine Harper's Ferry Rifles that are all correct and in excellent condition, this is your chance.



FINAL SALUTE

We have just found out that long time VGCA member Bob Tarcza has recently passed away. He was a kind, friendly gentleman and collector and will be missed. His Obituary from the Washington Times is shared below.

Robert Tarcza Obituary (2024) - Washington, DC

February 17, 1933 – September 13, 2024



Robert John Tarcza, of Fairfax Station, Virginia, passed peacefully with his family by his side on Friday, September 13, 2024, at Fairfax Hospital. Bob leaves behind his beloved wife of 67 years, Elsie; daughter Karen Laughman (Dale) of Glenmoore, Pennsylvania, son Ken (Beth) of Knoxville, Tennessee; five grandchildren Jennifer, Anna, Daniel, Aaron and Andrew, one great-grandson Henry; a brother, Greg (Ruth) of Colorado Springs, Colorado, three nieces, two nephews, and a host of wonderful friends and neighbors. He was predeceased by his brother Donald (Marsha) of Port St. Lucie, Florida, in 2018.

Bob was born and raised in New Brunswick, New Jersey, son of the late John Tarcza and Anna (Firsing) Tarcza, and was the oldest of three boys. He was active in Boy Scouts, building and flying model airplanes, and was the New Jersey State Junior Archery Champion as a teenager. Bob graduated from Rutgers University in 1955 and moved to Arlington, Virginia, where he began his career at the Navy Department. He married the love of his life, the former Elsie Mihaly, on September 22, 1957. Bob and Elsie settled in Vienna, Virginia in 1962, and raised their children there. He earned a bachelor's degree in mechanical engineering in 1964 and a master's degree in engineering administration in 1982, both from George Washington University.

Bob was an active participant in the communities he lived in and the organizations his children participated in. He remained a kid at heart throughout his life and was the dad the neighborhood kids wanted to play with because he had the best toys and always made time for them. He also made time to be a PTA President, volunteer as a Committee Chairman with the local Boy Scout troop and was a military history buff. All this while completing a 65-year career with the Navy Department, Defense Intelligence Agency and the Department of Defense as an engineer, analyst, and subject matter expert. Yes, Bob worked until he was 88!

A dedicated husband, father, grandfather and great-grandfather, honest, kind man of integrity, Bob leaves behind a family who never doubted his sincere love for them or their importance to him. No services are planned.



HAMPTON ROADS MILITARY SOCIETY

The Hampton Roads Militaria Society (HRMS) is a non-profit organization dedicated to assist collectors and historians in the collection & preservation of militaria of all sorts and periods, preserve and honor our military past, and honor the veterans of all our conflicts. They generally meet on the 2nd Tuesday of each month, but this can vary. The HRMS is a sister organization to the VGCA and VGCA members are welcome to participate as guests in their meetings and tours. Upcoming meetings (at Rescue Squad No. 8 at 1243 Bayne Drive in VA Beach) are:

28 Sep 2024 Field Trip. Members and guests will meet to tour the Casemate Museum at Fort Monroe. Admission to the Casemate Museum is free and self-guided. The Casemate Museum is now open to the public on Wednesday through Sunday 10 am – 4 pm and requires a FREE timed entry-ticket that **MUST** be picked up at the Visitor & Education Center (National Park Service) located at 30 Ingalls Road, Fort Monroe, VA. Web site https://fortmonroe.org/place_to_visit/casemate-museum/

08 Oct 2024 “Executive Outcomes, a private military company (PMC) founded in South Africa in 1989”
by Chris Galosi

It Happened in this Month...

September 13, 1994: The Federal Assault Weapons Ban was enacted in the United States. This law prohibited the manufacture for civilian use of certain semi-automatic firearms defined as “assault weapons”, as well as certain ammunition magazines that were defined as "large capacity".

September 14, 2004: The Federal Assault Weapons Ban expired. The law had a sunset provision, meaning it was written so as to expire after 10 years unless renewed by Congress and that did not happen.



★ Membership Chairman's Report – September

Please welcome the following new members to the VGCA:

- **Mike Lee** of Alexandria sponsored by Bruce Buchner
- **Pete Hoefler** of Saint Leonard sponsored by Rob Becker
- **Bill Cunningham** of Silver Spring sponsored by Kevin Showman
- **Glenn Davis** of Pasadena sponsored by Bruce Buchner
- **Michael Faucette** of Arlington sponsored by Bruce Buchner
- **Marius Vassiliou** of Fairfax sponsored by Bruce Buchner
- **Michael Williams** of Springfield sponsored by Tor Johnson

If you meet any of our new members at a regular meeting or our gun show, please introduce yourself and help them with orientation to our group.

If you know of anyone who would be interested in joining our organization, please invite them to a meeting or to our upcoming VGCA Gun Show. **If you sponsor a candidate, either at one of our membership tables or elsewhere, please make sure that you fill in and sign the Sponsor page.**

Notice to New Member Sponsors: VGCA has discontinued hard copy versions of the VGCA Newsletters. *Please make sure your prospective applicants **include a legible email address** and **telephone contact number** if at all possible and **make sure that your name is on the sponsorship form.*** Without an email address new members will NOT receive the newsletter or VGCA announcements.

Membership Numbers: There are currently 435 Life members and 87 Annual Members for a total of 522 members in the Virginia Gun Collectors Association, Inc.

Recruiting: Membership in the VGCA is a great way for people with an interest in the history, development, and use of firearms to broaden their knowledge and pass what they know on to others. It also offers the opportunity to network with individuals who have similar interests. To help facilitate new membership we have a Membership Table at every Chantilly and Fredericksburg gun show and also at our VGCA gun shows.

If you would like to volunteer to work a shift at the upcoming Chantilly show on the weekend of September 27th, please contact Bruce Buchner at buchnerb@cox.net.

Membership Renewal: I have gone through the roster and deleted all names that are not current on dues. **If you wish to continue receiving the Newsletter, getting into the VGCA gun shows for free, and other benefits that come with membership please get current on your dues.** You can renew annually for \$30 or \$150 for life. Please use the form below to renew and either mail it in or bring it to a meeting and give it to either George Dungan or Bruce Buchner. If you are unsure of your membership status email george@ecominv.com and I will let you know.

George Dungan, Vice President and Membership Chair

Annual Membership Renewals: Annual Membership renewals of \$30.00 are due by January 1, 2024. You may upgrade to Life Membership for \$150 (only \$120 over the cost of renewing your annual membership, plus no more annual dues requests). Failure to renew by the January Membership meeting may result in your being dropped as a *member in good standing*. **Members dropped for non-payment of dues will have to go through the new member process to re-join the Association.**

Dues may be paid by mail by sending a Check for \$30 (please, NO USPS or other Money Orders) and the completed membership renewal form above to the address on the form. VGCA will also accept payments in person (CHECK or EXACT CHANGE preferred – I have NO CASH for change) with a completed renewal form. If members have questions, please email **George Dungan, Interim Membership Chair** at george@eccominv.com or call me at 571-243-6387.

.....
Please detach and return with your payment

Membership Renewal Request (AMR-2023_Oct)
VGCA, Inc., P.O. Box 328, Manassas, VA 20108

Please complete and return this renewal form with your payment. Indicate Annual, Life or that you do not wish to renew your membership by checking the appropriate box below.

Please Print Clearly

Name: _____

Address: _____

Telephone: _____ Email: _____

- Enclosed is a check for \$30.00 for CY 2024 VGCA Annual Membership dues.
- I wish to upgrade to Life Membership in VGCA. Enclosed is a check for \$150.00.
- Remove my name from the VGCA membership roster.

Make all checks payable to VGCA (Please - NO CASH or Money Orders). If members have questions, please email **George Dungan, Interim Membership Chair** at george@eccominv.com or call me at 571-243-6387.

| VGCA Use Only | |
|---------------|--|
| Rec'd | |
| Paid | |
| Treas | |
| NL | |
| Due | |
| ID Iss | |

.....
Please detach and return with your payment



CMP UPDATE

By Marc Gorelick, CMP Liaison

The VGCA is a CMP Affiliated club. The VGCA club number is 026160.

M1917 RIFLE SALES



The Civilian Marksmanship Program (CMP) has a limited quantity of M1917 Enfield Rifles that are available for sale. Once this inventory of bolt action rifles is exhausted the CMP does not expect to get more. As of September 14, the inventory was 203 Service Grade and 1,067 Field Grade. The rifles will be sold via mail order and in CMP stores. Store sales may be limited due to inventory.

Service Grade M1917s cost \$1,100. Shipping and handling are included. Barrels may be dark and may have rust or pitting and worn rifling. The wood is sound but may have minor cracks, dings, dents and gouges. The metal may show normal wear and may exhibit some rust, pitting, and color variation. Rifles have been head spaced with a field gauge and function fired.

Field Grade M1917s are priced at \$1,000, including shipping and handling. Rifles may be missing minor screws, parts, and so on. Barrels may be dark and may have some rust or pitting or worn rifling. The wood may have cracks, dings, dents, gouges. Metal may show excessive wear and may exhibit rust or pitting and color variation. The rifles have been head spaced with a field gauge and function fired.

Effective June 26, 2024, customers are allowed to purchase up to six (6) bolt action rifles per year while supplies last. Additionally, if a customer has already purchased their limit of six (6) bolt action rifles they are authorized to bid on and purchase bolt action rifles for sale on the CMP auction site above the six (6) rifle limit.

All sales are AS-IS with NO RETURNS OR EXCHANGES. Customers must meet the CMP's eligibility requirements when placing an order.

For further information about M1917 sales go to the CMP website at:

<https://thecmp.org/sales-and-service/m1917-enfield-rifle-information/>.

For ordering information and to download an order packet, visit:

https://thecmp.org/cmp_sales/ordering-information/.

Membership in a CMP affiliated organization, like the VGCA, is required to purchase a rifle or ammunition. Go to the CMP webpage https://thecmp.org/cmp_sales/eligibility-requirements/ to see the CMP's eligibility requirements.

According to the CMP, M1903 rifles are sold out.

GUNSMITHING AT THE CMP CUSTOM SHOP



The CMP Custom Shop offers an extensive range of repair, upgrade, refinishing and customization services for a wide variety of US military rifles, particularly those that are collectibles – used in earlier periods. Services include, but are not limited to: custom rifle builds, rifle repair and restoration, barrel installation, rifle sight-in, and general technical inspection.

The CMP Custom Shop opened for business on October 1, 2013, and has a reputation for customer service, quality work and reasonable turnaround for most work. It specializes in working on USGI rifles that the CMP is selling or has sold in the recent past; those produced at a US armory (Springfield or Rick Island) or USGI

contractor. Rifles are the M1 Garand, M1 Carbine, M1903 and M1903A3 Springfield, the M1917 and the Krag-Jorgenson. Other US rifles like the Remington 40X, Mossberg 44 and H&R Model 12 can also be serviced if needed. The CMP Custom Shop will NOT work on shotguns, pistols, revolvers, M14/M1A, M-16/AR15 style rifles or other commercially produced modern rifles. Nor will it work on non-USGI copies of the M1 Garand, 1903 Springfield and especially the M1 Carbine. For further information visit the CMP website at: https://thecmp.org/cmp_sales/custom-gunsmithing/.

NEW CMP E-MAIL ADDRESSES

In order to improve its customer service, the CMP has set up a dedicated email address for customers to use to check the status of their order. Customers are encouraged to email orderstatus@thecmp.org to check the status of their order or ask questions regarding their order. CMP staff will answer the emails in the order they receive them. The CMP has also added a dedicated email, hello@thecmp.org, for individuals with questions for the CMP.

CMP GIFT CERTIFICATES



CMP Gift Certificates can be used toward anything the CMP sells – match entry fees, clothing, rifles, and competition equipment – and can be loaded with any amount, with a minimum of \$20 and a maximum of \$1,500. CMP Gift Certificates are now available on the CMP eSTORE in denominations of \$50, \$100 or \$500. Certificates can also be purchased in person at any of the CMP's stores or ranges in Ohio and Alabama, or customers may send

in an order form for any amount, between \$20 and \$1,500. Certificates are treated the same as cash and are non-refundable and non-replaceable if lost or stolen. They are valid for one year from the issue date and are only redeemable for goods and services. For additional information go to:

https://thecmp.org/cmp_sales/cmp-gift-certificates/.



★ Show-n-Tell ★

NOTE: For anyone bringing in items for Show-n-Tell - please hold the item up so the members in attendance can see it. This will also help your photographer get a sharp picture and allow people who could not attend the meeting to see it clearly in the newsletter. We also ask that you provide a Fact Sheet (copies of the one below will be provided at the meeting) to assist the newsletter editor in accurately describing your item. Thank you!

VGCA Show-n-Tell Fact Sheet

Manufacturer: _____

Model: _____ Action Type: _____

Caliber: _____

Years of Production: _____ Total Produced: _____

Year this example was manufactured (if known): _____

Significance: _____

Question(s) for members: _____

Name (optional): _____

Where acquired (optional): _____ When acquired (optional): _____

A message from your VGCA Photographer--

I ask those who bring items in for Show-and-Tell to PLEASE hold the item UP and in view of the audience so that they can be seen clearly, and so that I might be able to get a decent picture for the newsletter. PLEASE stand behind the tables and simply hold the item at chest or waist level, face forward, stand still, and give me a five or six seconds to grab a decent photograph of the Show-and-Tell item.

If you do not want your Show-and-Tell item to be shared with other VGCA members, just tell me in advance and I will not attempt to take a photo of it.

I do the photography for the VGCA and its' members, not for myself, and not for any personal gain. Your assistance in documenting your items will be a great help. I spend an average of five hours editing the pictures for the newsletter and not having a clear view of the subject has been a great and constant frustration for me.

Your help will assist in making a better newsletter for all VGCA members. Thank you!

Jack Looney

JUNE SHOW-N-TELL



Member 1 presented an “inch-pattern” FAL that is a parts build (*left*). It was made with a mix of Canadian and UK parts on a US-made Enterprise Arms receiver. It has a Canadian military 1.5x scope (only 800 made) on quick detach mount, bayonet, and blank firing adapter. It is in .308 caliber and was purchased in Columbia, SC in 1998.

Member 2 brought in an Israeli FAL (*right*). It is a heavy-barrel variant imported as a complete rifle by Armscorp before 1989. Member 2 also shared an Armscorp price list dated September 15, 1989 – ahhh, the good ol’ days!



Member 3 shared an example of the B&T produced TP9 small personal defense (PDW) weapon in 9mm (*right*). B&T is a Swiss company that started out making suppressors. The TP9 utilizes a closed bolt and rotating barrel action and is one of the smallest PDWs available. Unfortunately, its takedown and re-assembly is pretty complicated! This example was purchased last year.



Member 4 brought in two guns to show, the first being a Lee-Enfield No. 1 Mk III (*left*). Chambered in .303 British, this bolt action rifle with its 10-round magazine was replaced in British service during WWII by the updated No. 4 Mk I and No. 5 Mk I. However, the No. 1 Mk III continued to “soldier on” around the world for many more years. This example was made in India in 1948.



The second firearm shared by Member 4 was a Model 21 Glock pistol in 45 ACP (*right*). This pistol is Gen 5 (5th generation) Glock with an optics cut on the top of the slide. It is slightly larger than earlier versions so it may not fit in certain holsters.

Both guns were purchased at a Dulles gun show in 2024.

Member 5 brought in a Beretta BM-62 rifle configured as an Italian BM-59 (right). The BM-59 was Italy's update to the venerable M1 Garand and featured a permanently mounted grenade launcher, bipod, and muzzle brake. Only 2000 of the BM-62s were imported to the US. Member 5 acquired this example online earlier this year.



Member 6 shared yet another semi-auto FAL, this one made by Imbel in Brazil and imported by Pacific Armament (left). Chambered in 7.62x51mm, it was purchased from Glenn Zanders Sporting Goods in 2000. The original invoice listed it as an "SSG 558 Carbine" – it is not!

★ Upcoming Events and Shows ★

PLEASE NOTE: VGCA members are strongly encouraged to verify shows before driving to an event. These dates were confirmed when this newsletter was written but are not guaranteed. Shows highlighted in **yellow** are shows with a collector focus.

VIRGINIA – 2024

- ⇒ Sep 27-29, 2024 – Chantilly, VA – Dulles Expo Center – *Showmasters*
- ⇒ Oct 12-13, 2024 – Fredericksburg, VA – Fredericksburg Fairgrounds (**new location!**) – *SGK*
- ⇒ **Oct 19-20, 2024 – Dale City, VA – Dale City VFW Post #1503 – VGCA (OUR SHOW!)**
- ⇒ Oct 19-20, 2024 – Virginia Beach, VA – Virginia Beach Convention Center - *SGK*
- ⇒ Oct 19-20, 2024 – Salem, VA – Salem Civic Center – *C&E Gun Shows*
- ⇒ Nov 2-3, 2024 – Harrisonburg, VA – Rockingham County Fairgrounds – *Showmasters*
- ⇒ Nov 9-10, 2024 – Richmond, VA – Richmond Raceway Complex – *Showmasters*
- ⇒ Nov 16-17, 2024 – Fishersville, VA – Augusta Expo – *Showmasters*
- ⇒ Nov 22-24, 2024 – Chantilly, VA – Dulles Expo Center – *Showmasters*
- ⇒ Nov 30-Dec 1, 2024 – Hampton, VA – Hampton Roads Convention Center – *SGK*

MARYLAND – 2024

- ⇒ Sep 21-22, 2024 – Crownsville, MD – Anne Arundel Fairgrounds – *Appalachian Promotions*
- ⇒ Sep 21-22, 2024 – Ocean City, MD – Ocean City Convention Center – *Showmasters*
- ⇒ Oct 5-6, 2024 – Timonium, MD – Timonium Fairgrounds – *Appalachian Promotions*
- ⇒ **Nov 2-3, 2024 – Easton, MD – Easton Vol Fire Dept – Eastern Shore Arms Collectors**
- ⇒ Nov 9-10, 2024 – Frederick, MD – Frederick Fairgrounds – *Appalachian Promotions*
- ⇒ Dec 7-8, 2024 – West Friendship, MD – Howard Cnty Fairgrounds – *Appalachian Promotions*

PENNSYLVANIA – 2024

- ⇒ Sep 21-22, 2024 – Morgantown, PA – Morgantown Expo Center – *Eagle Shows*
- ⇒ Sep 21-22, 2024 – Washington, PA – Washington PA County Fairgrounds – *ARH Sport Shop*
- ⇒ Sep 28-29, 2024 – Allentown, PA - ParkView Inn & Conference Center - *Eagle Shows*
- ⇒ **Sep 28-29, 2024 – Gettysburg, PA – Redding Auction Hall – Central Pennsylvania Antique Arms Association**
- ⇒ Sep 28-29, 2024 – West Middlesex, PA – Hidden Valley Sportsmen’s Club – *Hidden Valley Sportsmen’s Club*
- ⇒ Oct 5-6, 2024 – Gettysburg, PA – Allstar Events Complex – *Eagle Shows*
- ⇒ Oct 5-6, 2024 – New Providence, PA – Southern Lancaster County Farmer-Sportsmen’s Association Clubhouse – *SLCFSA*
- ⇒ Oct 5-6, 2024 – Tobyhanna, PA – VFW Post #3448 – *Jaeger Arms*
- ⇒ Oct 12-13, 2024 – Monroeville, PA – Monroeville Convention Center – *Showmasters*
- ⇒ Oct 12-13, 2024 – Bloomsburg, PA – Bloomsburg Fairgrounds – *Eagle Shows*
- ⇒ Oct 12-13, 2024 – Franklin, PA – Rocky Grove Fire Hall – *Rocky Grove Vol. Fire Dept*
- ⇒ Oct 18-20, 2024 – Oaks, PA – Greater Philadelphia Expo Center – *Eagle Shows*
- ⇒ **Oct 19-20, 2024 – Allentown, PA – Allentown Fairgrounds – Forks of the Delaware Historical Arms Society**
- ⇒ Oct 19-20, 2024 – East Berlin, PA – 1808 Fish and Game Rd – *East Berlin Fish & Game Assoc.*
- ⇒ Oct 26-27, 2024 – York, PA – York Fairgrounds – *Appalachian Promotions*
- ⇒ Nov 2-3, 2024 – Harrisburg, PA – PA Farm Show Complex – *C&E Gun Shows*
- ⇒ Nov 2-3, 2024 – Quarryville, PA – Solanco Fairgrounds – *Eagle Shows*

PENNSYLVANIA – 2024 (continued)

- Nov 8-9, 2024 – Gettysburg, PA – Gettysburg Fire Dept – *Hallowed Ground Militaria & Historic Arms Show*
- Nov 9-10, 2024 – Kempton, PA – Kempton Community Center – *Jaeger Arms*
- Nov 16-17, 2024 – Allentown, PA - ParkView Inn & Conference Center - *Eagle Shows*
- Nov 16-17, 2024 – Leesport, PA – Leesport Farmers Market – *Appalachian Promotions*
- Nov 16-17, 2024 – Sellersville, PA – Forrest Lodge VTW245 – *Jaeger Arms*
- Nov 17, 2024 – Portland, PA – William Pensyl Social Hall – *Portland Hook & Ladder Co. No. 1*
- Nov 23-24, 2024 – Kutztown, PA – Kutztown Fairgrounds – *Appalachian Promotions*
- Dec 7-8, 2024 – Allentown, PA – Allentown Fairgrounds – *Forks of the Delaware Historical Arms Society*
- Dec 7-8, 2024 – Trevoise, PA – Radisson Philadelphia Northeast – *Eagle Shows*
- Dec 14-15, 2024 – Harrisburg, PA – PA Farm Show Complex – *C&E Gun Shows*

SPECIAL EVENTS / SHOWS – 2024

- Sep 19-22, 2024 – York, PA – York Expo Center – *Ohio Valley Military Society – MAX Show*
- Sep 21-22, 2024 - Wilmington, OH – Roberts Convention Centre – *Ohio Gun Collectors Association – Winchester Arms Collectors Association and German Gun Collectors Association*
- Oct 2-6, 2024 – Winchester, VA - Fort Shenandoah (480 Chalybeate Springs Rd) – *North-South Skirmish Association* – this the N-SSA's 150th National Match and the Sutler's Row will be full of vendors with antique and reproduction firearms and accessories
- Nov 9-10, 2024 – Tulsa, OK – Expo Square (Tulsa Fairgrounds) – *Wanenmacher – World's Largest Gun Show – 4200+ tables!*

NOTE: OGCA Gun Shows are not open to the public – they are restricted to members and invited guests only. That said, several VGCA members are also members of the OGCA and can sponsor you if you are interested in attending.

FOR SALE:

The "For Sale" section of the Virginia Gun Collectors Association (VGCA) Newsletter is provided as a service exclusively to the members of the VGCA and is intended for listing firearms and firearm related items. The VGCA, its officers, and directors are not responsible for any listings made in any VGCA Newsletter. We are not responsible for the accuracy (condition, value, etc.) of any listings. All buyers, traders, and sellers agree to comply with all local, state, federal, and international laws in regard to items sold via the VGCA Newsletter. It is their duty and responsibility to ensure the quality and value of the transaction and that all such laws are followed at all times. Buy, sell, or trade at your own risk.

If you would like to list an item (or items) in the VGCA Newsletter, please send your description, price, and contact information to rpebecker@verizon.net. I must receive your material no later than the second Sunday of the month for it to be included in that month's newsletter. Items will be listed for one issue of the Newsletter.

FOR SALE:

✪ **FINNISH MOSIN-NAGANT** is authored by VGCA member Matt DiRisio and published by Wet Dog Publications. The list price is \$99.95. It is 584 pages long with over 1,500 color and black and white photographs.



For ordering information go to the Wet Dog Publications website at:

<https://www.fnbrowning.com/book-finnish-mosin-nagant>.

FOR SALE:

✪ After more than two and a half years of research, VGCA member Bill Vanderpool has published his book **Guns of the FBI**. This book is available at GunDigest.com or can be purchased directly from Bill by calling 703-626-2975. He is more than happy to sign a copy for you. Cost is \$50.00.

FOR SALE:

✪ VGCA member Charlie Pate has four books that he has authored for sale, at discounted prices to VGCA members. These include:

- "U.S. Handguns of World War II" - \$45.00
- "The Smith & Wesson American Model" - \$55.00
- "U.S. Military Arms Inspector Marks" - \$45.00
- "The Colt Model 1860 Army Revolver" - \$60.00

If interested, please contact Charlie at usarmsresearch@gmail.com

FOR SALE:

✪ VGCA member Larry Babcock has published a companion piece to his earlier book **M1 Garand Photo Essay**. This second book, titled **M1 Garand Photo Essay Volume II** covers all new material, to include the M1C and M1D sniper rifles as well as a myriad of M1 accessories. Best of all, both books are offered at a discount to VGCA members. Volume I is normally priced at \$69 and volume II lists for \$49, VGCA members can buy them directly from Larry for \$60 and \$40 each respectively - or \$90 total if you buy both. Look for Larry Babcock set up near the VGCA recruiting table at the next Chantilly Gun Show or order from him directly at larrybab@comcast.net / or text to 703-856-2561.

WANT TO BUY:

✪ Browning lever action Gold Medallion, short action, blue or silver.

Also: Browning lever action with pistol grip and take down. Prefer .308 but any considered.

Call King at 703 576-7016, if no answer leave name and number with brief description.

Thank you, King von Schilling

WANT TO BUY:

★ Seeking a Bagnold Sun Compass, used during WWII by British desert troops. It was mounted on their vehicles. Must be complete and in working order. Contact Jack via email to looney.house@verizon.net or text to 703-999-9458.



The e-mail address for any Newsletter-related matters is Newsletter@vgca.net - or you can reach the editor directly at rpebecker@verizon.net. Feel free to e-mail items for inclusion in the newsletter. For changes of address or non-receipt of the newsletter, either via e-mail or the mailed hard copy, please contact Rob Becker or George Dungan.